

Article number: 12708000050500
Description: KLEE-coil 708 000 050.500
M5 St. steel 1.4305

Measures

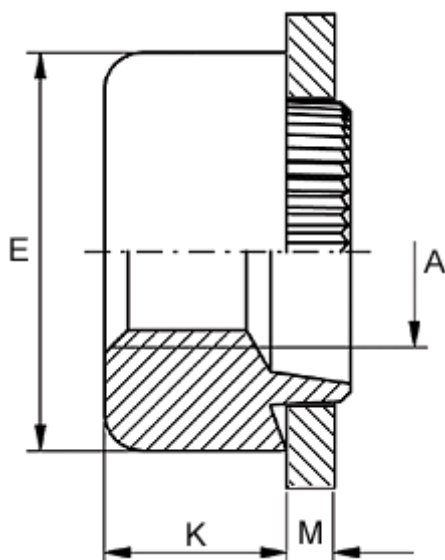

Female thread A	= M5
Height K	= 3.0
Outer diameter E	= 11.0
Plate thickness	= 2.0 to 2.2
Recommended bore diameter for extreme load	= 8.0
Recommended bore diameter for normal use	= 8.0